

Application data sheet A_HCM-03_4.16_HQ

Full air conditioning plant, heating/cooling/humidification/dehumidification with room / supply air cascade control



The plant has speed-controlled fans, hot water heating coil, chilled water cooling coil, steam humidifier and hot water reheating coil.

The most important functions:

- Temperature control with room / supply air cascade control (minimum and maximum limitation)
- Humidity control with room / supply air humidity cascade control (maximum limitation)
- Fan pressure control

Plant diagram

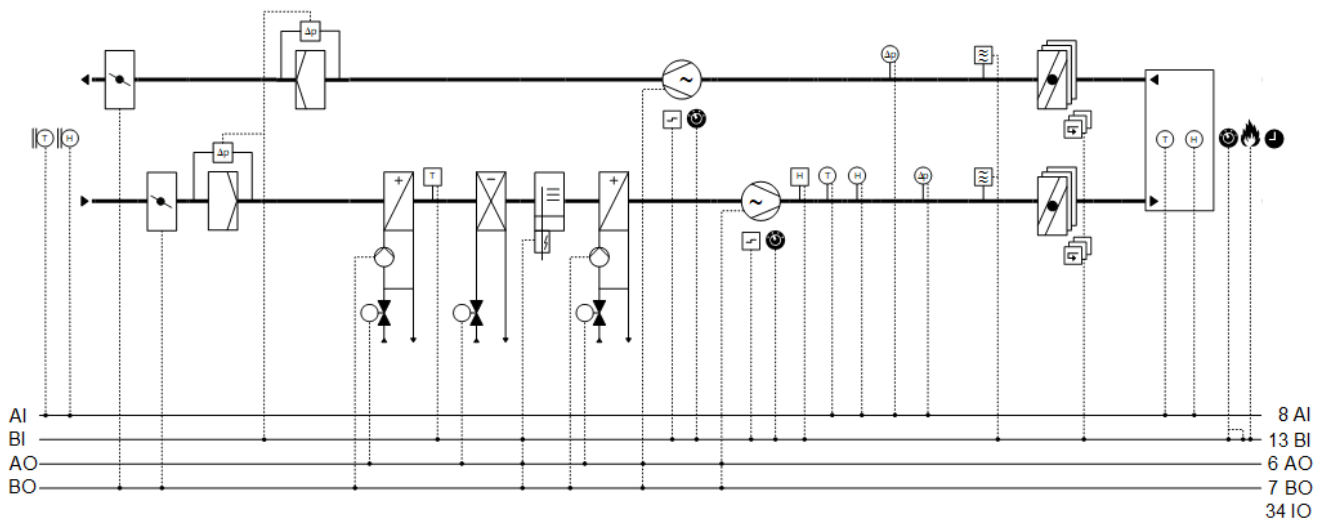

Function diagrams / sequence diagrams

Temperature cascade control

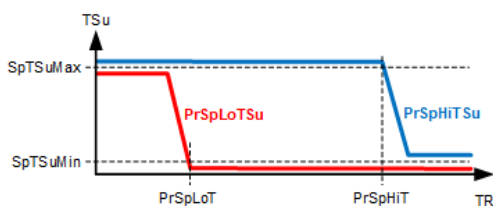

TSu	Supply air temperature
SpTSuMax	Maximum supply air temperature setpoint
PrSpLoTSu	Present setpoint low for supply air temperature
PrSpHiTSu	Present setpoint high for supply air temperature
SpTSuMin	Minimum supply air temperature setpoint
PrSpLoT	Present setpoint low for temperature
PrSpHiT	Present setpoint high for temperature
TR	Room temperature

Supply air temperature control

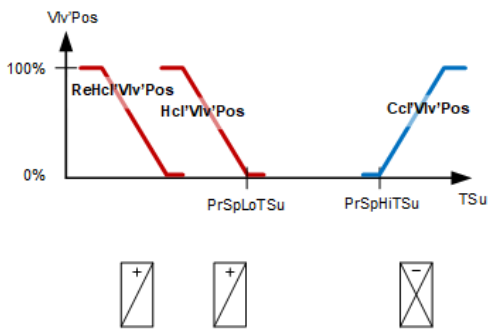

Vlv'Pos Valve position
 ReHcl'Vlv'Pos Reheating coil valve position
 Hcl'Vlv'Pos Heating coil valve position
 Ccl'Vlv'Pos Cooling coil valve position
 PrSpLoTSu Present setpoint low for supply air temperature
 PrSpHiTSu Present setpoint high for supply air temperature

Note: The heating coil is locked during dehumidification (Hcl'Vlv'Pos).

Seasonal temperature compensation

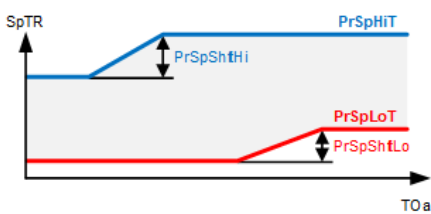

SpTR Room temperature setpoint
 PrSpHiT Present setpoint high for temperature
 PrSpShftHi Present setpoint shift high
 PrSpLoT Present setpoint low for temperature
 PrSpShftLo Present setpoint shift low
 TOa Outside air temperature

Humidity cascade control

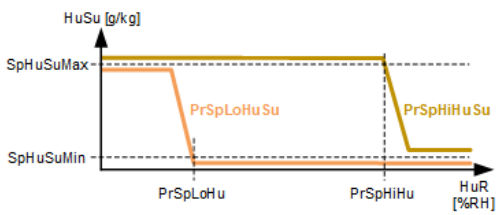

HuSu Supply air humidity
 SpHuSuMax Maximum setpoint for supply air humidity
 PrSpLoHuSu Present setpoint low for supply air humidity
 PrSpHiHuSu Present setpoint high for supply air humidity
 SpHuSuMin Minimum setpoint for supply air humidity
 PrSpLoHu Present setpoint low humidity
 PrSpHiHu Present setpoint high humidity
 HuR Room air humidity (Extract air humidity, HuEx)

Supply air humidity control

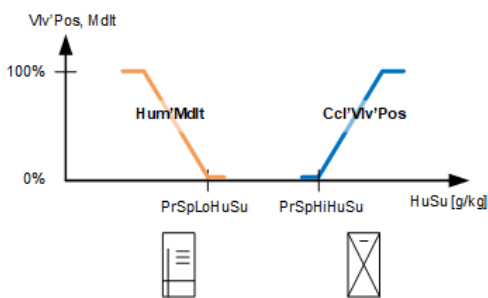

Vlv'Pos, Mdl Valve position, Modulating
 Hum'Mdl Modulating control of the humidifier
 Ccl'Vlv'Pos Cooling coil valve position
 PrSpLoHuSu Present setpoint low for supply air humidity
 PrSpHiHuSu Present setpoint high for supply air humidity
 HuSu Supply air humidity

Pressure control

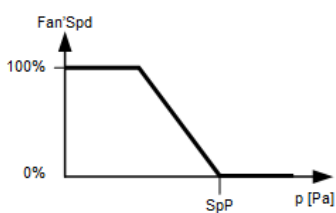

Fan'Spd Fan speed
 SpP Pressure setpoint
 P Pressure

Description of functions

Temperature cascade control (Room / supply air temperature cascade)

Calculates the high and low supply air setpoint per the outside temperature.

See Function diagram Temperature cascade control.

Basic setpoints for temperature control

Setpoints for upper and lower room temperature

See Function diagram Seasonal temperature compensation.

Seasonal temperature compensation

Corrects the high and low room temperature setpoint per the outside temperature.

See Function diagram Seasonal temperature compensation.

Humidity cascade control (Room / supply air humidity cascade)

Calculates the high and low supply air setpoint per the room humidity.

See Function diagram Humidity cascade control.

Basic setpoints humidity control

Setpoints for upper and lower room humidity

See Function diagram Supply air humidity control.

Present operating mode

Reports the present operating mode: Off | On

Reason for present operating mode

Reports the reason for the present mode:

Exception | Operating mode switch | Manual operating mode | Scheduler | Switching action operating

Manual operating mode selection







Switches the plant to: Auto | Off | On





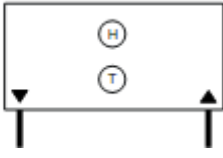

Night cooling (Freecooling)





Switches on the fans, if the conditions are met to cool the room air outside the operating mode On.

Common fault (Fault indicators)

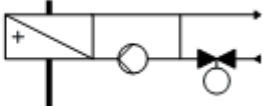
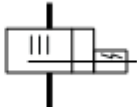
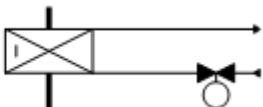
Displays on HMI/PXM.

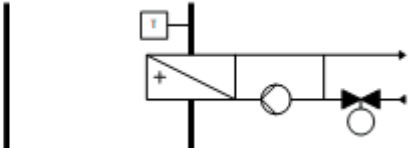
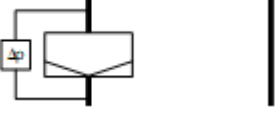
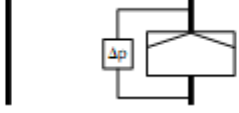
Component	Function
	Fire detector contact (Fire control panel) Switches the plant off.
	External manual Operating mode switch Switches the plant to: Auto Off On
	Scheduler program Switches the plant to: Off On
	Room temperature sensor Measures room temperature (° C). Sustained mode: Switches on the plant when the setpoint is breached. Room humidity sensor Measures the room humidity (%).
	Fire dampers Visualizes the state (state message): Close Open Switches plant to Off, if the plant is operating and the dampers are not open.
	Smoke detector (in supply air and extract air) Switches the plant to: Off Both smoke detector contacts are switched in series.
	Supply air differential pressure sensor Measures the differential pressure between duct and environment.

Component	Function
	<p>Exhaust air differential pressure sensor Measures the differential pressure between duct and environment.</p>
	<p>Supply air humidity sensor Measures supply air humidity.</p>
	<p>Supply air temperature sensor Measures the supply air temperature.</p>
	<p>Supply air humidity detector Limits the maximum relative supply air humidity.</p>
	<p>Supply air fan Controls the supply air pressure.</p>
	<p>Maintenance switch Switches off the fan and the plant. The fan outputs are blocked locally at a high priority.</p>
	<p>Fault message Fault messages, e.g. from the external motor control (variable speed drives). Switches off the fan and the plant.</p>
	<p>Exhaust air fan Controls extract air pressure.</p>
	<p>Maintenance switch Switches off the fan and the plant. The fan outputs are blocked locally at a high priority.</p>
	<p>Fault message Fault messages, e.g. from the external motor control (variable speed drives). Switches off the fan and the plant.</p>
	<p>Reheating coils Controls the supply air temperature.</p>
	<p>Reports hot water demand to heat distribution.</p>
	<p>Kick function: Prevents the pump from seizing during long idle periods.</p>
	<p>Humidifier (Steam humidifier)</p>
	<p>Humidity controller Controls supply air humidity (humidification).</p>
	<p>Protects against too high relative supply air humidity by reducing the humidifier power. The humidity detector is less likely to react.</p>
	<p>Command Switches on/off the humidifier as needed.</p>
	<p>Control Controls the humidifier: 0 and 100 [%].</p>
	<p>Cooling coil Controls the supply air temperature.</p>
	<p>Dehumidification using the cooling coil Controls supply air humidity. See Function diagram Supply air humidity control.</p>
	<p>Reports chilled water demand to refrigeration distribution.</p>

Component	Function
	<p>Heating coil Controls the supply air temperature.</p> <p>Reports hot water demand to heat distribution.</p> <p>Pump run when the outside air temperature is low Pump always operates at low outside temperatures.</p> <p>Frost protection Prevents the hot water heating coil from freezing. If the frost protection monitor triggers:</p> <ul style="list-style-type: none"> ● The plant switches off. ● The valve fully opens (100%) and the pump is also switched on. Both at high priority (Prio 4). <p>Purge optimization Purges the heating coil with hot water at cold outside temperature prior to switching on fans. Duration and valve opening are optimized using function [PURGE] purge optimization.</p> <p>Kick function Prevents the pump from seizing during long idle periods.</p>
	<p>Extract air filter Maintenance message after reaching the limit value for operating hours or differential pressure monitoring.</p>
	<p>Outside air filter Maintenance message after reaching the limit value for operating hours or differential pressure monitoring.</p>
	<p>Outside air damper Opens and closes the outside air damper. Adjustable damper runtime in the program.</p>
	<p>Exhaust air damper Opens and closes the exhaust air damper. Adjustable damper runtime in the program.</p>
	<p>Outside air humidity sensor Measures outside air humidity. No control function (information only).</p>
	<p>Outside air temperature sensor Measures outside temperature.</p>

Device list

Key	Device type	Data sheet	Type	No.
Automation station	Automation station with 16 inputs/outputs, BACnet/IP communication	A6V11646018_en	PXC4.E16	1
TXM1_ Module	I/O module with 4 digital inputs and 3 relay outputs	A6V12027167	TXM1.4D3R	1
TXM1_ Module	Digital input module with 8 data points	A6V10068525	TXM1.8D	1
TXM1_ Module	Universal module with 8 inputs/outputs	A6V10068529	TXM1.8U	1
TXA1_ address key	Address key 1...12 and a deletion key	A6V10365858	TXA1.K12	1
Touch panel	BACnet/IP touch panel 7.0" with integrated web server	A6V11664137	PXM40.E	1
Room temperature sensor Room humidity sensor	Flush-mount room sensor with: Front module, humidity and temperature (Active, LG-Ni1000) Base module for temperature and/or humidity measurement, 70.8 x 70.8 mm	N1410	AQR2534ANW AQR2540NF AQR2510NFW (Design frame)	1
Supply air pressure sensor	Air duct differential pressure sensor, 0...200 Pa, 0...250 Pa, 0...500 Pa	N1910	QBM2030-5	1
Extract air pressure sensor	Air duct differential pressure sensor, 0...200 Pa, 0...250 Pa, 0...500 Pa	N1910	QBM2030-5	1
Supply air temperature sensor Supply air humidity sensor	Air duct sensor for humidity (DC 0...10 V) and temperature (LG-Ni1000)	N1864	QFM2120	1
Humidity detector	Duct hygrostat, setpoint setting range 15...95 % r.h., setpoint adjuster inside	N1514	QFM81.21	1
Frost temperature, Frost protection monitor	Frost protection monitor, 2-position, capillary 3000 mm	N1284	QAF81.3	1
Filter detector, outside and extract air	Differential pressure switch	N1552	QBM81-...	2
Outside air temperature Outside air humidity	Air duct for humidity (DC 0...10 V) and temperature (LG-Ni1000).	N1864	QFM2120	1
Fire dampers, supply air	Actuator for fire dampers, 2-position, spring return 90/15 s, 2 auxiliary switches	+	G.A.26.1E/T1...	1
Fire damper, extract air	Actuator for fire dampers, 2-position, spring return 90/15 s, 2 auxiliary switches	+	G.A.26.1E/T1...	1
Air damper actuator, outside air	Air damper rotary actuators, 2-point	+	G.....1.	1
Air damper actuator, exhaust air	Air damper rotary actuators, 2-point	+	G.....1.	1
Heating coil valve	2-port or 3-port valve. Modulating actuator for valves, AC 24 V, DC 0...10 V	+	VV.. / VX.. / M.. / VP.. / EV.. S..6...	1 1
Cooling coil valve	2-port or 3-port valve. Modulating actuator for valves, AC 24 V, DC 0...10 V	+	VV.. / VX.. / M.. / VP.. / EV.. S..6...	1 1
Air humidifier valve	2-port or 3-port valve. Modulating actuator for valves, AC 24 V, DC 0...10 V	+	VV.. / VX.. / M.. / VP.. / EV.. S..6...	1 1
Reheating coil valve	2-port or 3-port valve. Modulating actuator for valves, AC 24 V, DC 0...10 V	+	VV.. / VX.. / M.. / VP.. / EV.. S..6...	1 1

+ Refer to product catalog on selection of actuators and valves.

Connection diagram

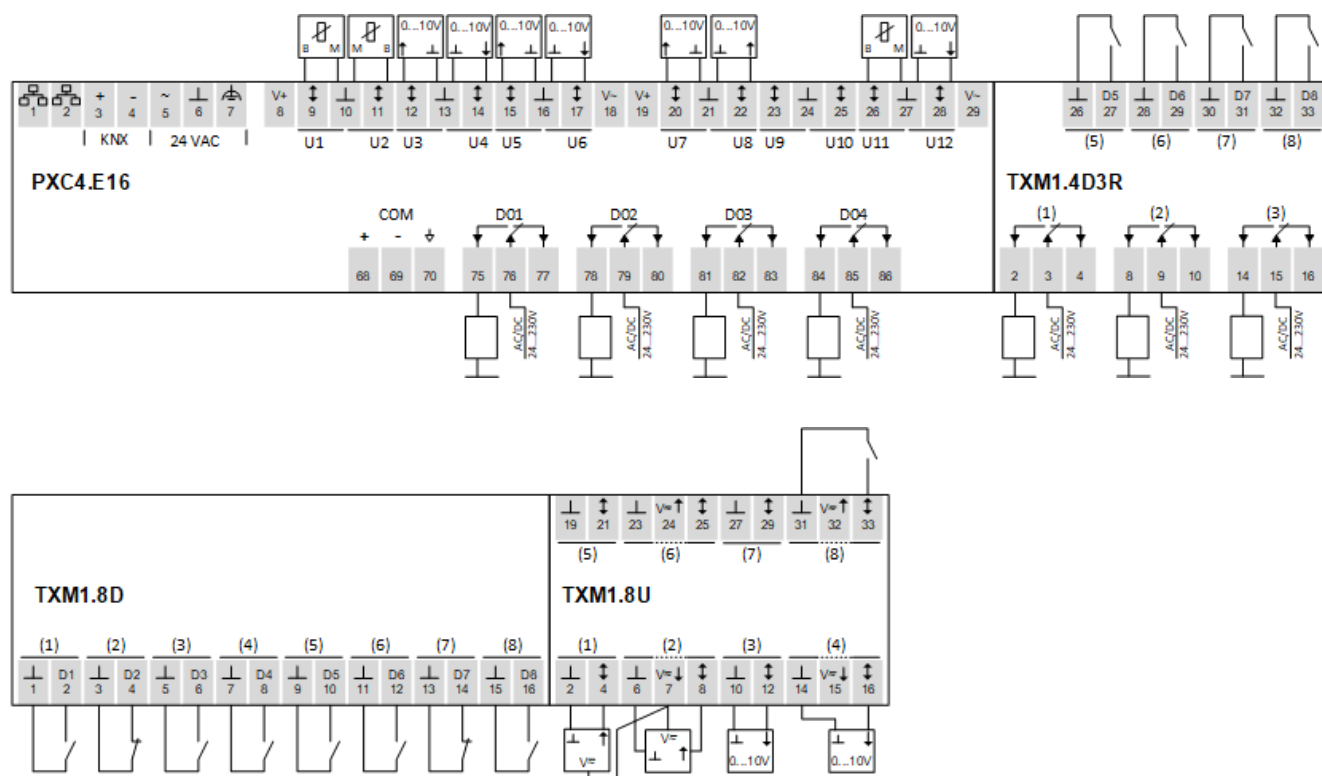

Designations inputs/outputs

PXC4.E16		TXM1.4D3R (Address 1)		TXM1.8D (Address 2)	
U1	Supply air temperature	(1)	Exhaust air damper, command	(1)	Fire dampers, supply air and extract air
U2	Room temperature	(2)	Air humidifier, pump command	(2)	Smoke detector, supply air and extract air
U3	Heating coil, valve position	(3)	Reheater heating coil, pump command	(3)	Supply air fan, maintenance switch
U4	Supply air fan, supply air pressure	(5)	Frost protection monitor	(4)	Supply air fan, fault
U5	Supply air fan, speed	(6)	Fire detection contact	(5)	Exhaust air fan, maintenance switch
U6	Exhaust air fan, extract air pressure	(7)	Operating mode switch [Off]	(6)	Exhaust air fan, fault
U7	Exhaust air fan, speed	(8)	Operating mode switch [On]	(7)	Humidity detector
U8	Cooling coil, valve position			(8)	Filter detector, outside and extract air
U9		TXM1.8U (Address 3)			
U10		(1)	Supply air humidity		
U11	Outside temperature	(2)	Room air humidity		
U12	Outside air humidity	(3)	Air humidifier, valve position		
DO1	Supply air fan, command	(4)	Reheating coil, valve position		
DO2	Exhaust air fan, command	(5)			
DO3	Heating coil, pump command	(6)			
DO4	Outside air damper, command	(7)			
		(8)	Air humidifier, fault		

Overview of inputs and outputs

Designation input/output	Short name	Type	Signal/connection	Unit	Alarm	Trend	Device duct number
Fire detection contact	FireDetCont	BI	NO contact		Yes		TXM1.4D3R, (6)
Operating mode switch	OpModSwi	MI (2 BI)	NO contact NO contact				TXM1.4D3R, (7) TXM1.4D3R, (8)
Room temperature	TR	AI	LG-Ni1000	[° C]	Yes ¹⁾	Yes ²⁾	PXC4.E16, U2
Room air humidity	HuR	AI	0...10 [V]	[rh]	Yes ¹⁾	Yes ²⁾	TXM1.8U, (2)
Fire dampers, supply air and extract air	Fdps'Fbopnd	BI	NO contact				TXM1.8D, (1)
Smoke detector, supply air and extract air	Su'Ex'SmkDet	BI	NC contact				TXM1.8D, (2)
Supply air temperature	TSu	AI	LG-Ni1000	[° C]	Yes ¹⁾	Yes ³⁾	PXC4.E16, U1
Supply air humidity	HuSu	AI	0...10 [V]	[rh]	Yes ¹⁾	Yes ³⁾	TXM1.8U, (1)
Humidity detector	HuDet	BI	NC contact		Yes		TXM1.8D, (7)
Supply air pressure sensor	FanSu'Psu	AI	0...10 [V]	[Pa]	Yes		PXC4.E16, U4
Supply air fan, speed	FanSu'Spd	AO	0...10 [V]	[%]			PXC4.E16, U5
Supply air fan, command	FanSu'Cmd	BO	NO contact				PXC4.E16, DO1
Supply air fan, maintenance switch	FanSu'MntnSwi	BI	NO contact		Yes		TXM1.8D, (3)
Supply air fan, fault	FanSu'Flt	BI	NO contact		Yes		TXM1.8D, (4)
Reheating coil, valve position	ReHcl'Vlv'Pos	AO	0...10 [V]	[%]			TXM1.8U, (4)
Reheater heating coil, pump command	ReHcl'Pu'Cmd	BO	NO contact				TXM1.4D3R, (3)
Air humidifier, valve position	Hum'Mdlt	AO	0...10 [V]	[%]			TXM1.8U, (3)
Air humidifier, pump command	Hum'Cmd	BO	NO contact				TXM1.4D3R, (2)
Air humidifier, fault	Hum'Flt	BI	NO contact		Yes		TXM1.8U, (8)
Cooling coil, valve position	Ccl'Vlv'Pos	AO	0...10 [V]	[%]			PXC4.E16, U8
Frost protection monitor	Hcl'FrPrtMon	BI	NO contact		Yes		TXM1.4D3R, (5)
Heating coil, valve position	Hcl'Vlv'Pos	AO	0...10 [V]	[%]			PXC4.E16, U3
Heating coil, pump command	Hcl'Pu'Cmd	BO	NO contact				PXC4.E16, DO3
Extract air pressure sensor	FanEh'PEx	AI	0...10 [V]	[Pa]	Yes		PXC4.E16, U6
Exhaust air fan, speed	FanEh'Spd	AO	0...10 [V]	[%]			PXC4.E16, U7
Exhaust air fan, command	FanEh'Cmd	BO	NO contact				PXC4.E16, DO2
Exhaust air fan, maintenance switch	FanEh'MntnSwi	BI	NO contact		Yes		TXM1.8D, (5)
Exhaust air fan, fault	FanEh'Flt	BI	NO contact		Yes		TXM1.8D, (6)
Outside air damper, command	DmpOa'Cmd	BO	NO contact				PXC4.E16, DO4
Exhaust air damper command	DmpEh'Cmd	BO	NO contact				TXM1.4D3R, (1)
Filter detector, outside and extract air	FltDet	BI	NO contact		Yes		TXM1.8D, (8)
Outside air temperature	TOa	AI	LG-Ni1000	[° C]	Yes ¹⁾		PXC4.E16, U11
Outside air humidity	HuOa	AI	0...10 [V]	[rh]	Yes ¹⁾		PXC4.E16, U12

¹⁾ An alarm is generated in the event of a short circuit or interruption

²⁾ Trending every 15 minutes

³⁾ Trending every minute

Device	Total inputs and outputs per device	Planned number of inputs/outputs in use			
		Analog inputs	Analog outputs	Binary inputs	Binary outputs
PXC4.E16	16	6	4		4
TXM1.4D3R	7			4	3
TXM1.8D	8			8	
TXM1.8U	8	2	2	1	
Amount	39	8	6	13	7

Reserve inputs and outputs: 5 universal inputs and outputs (see Connection diagram)

Mechanical dimensions

Automation station PXC4.E16

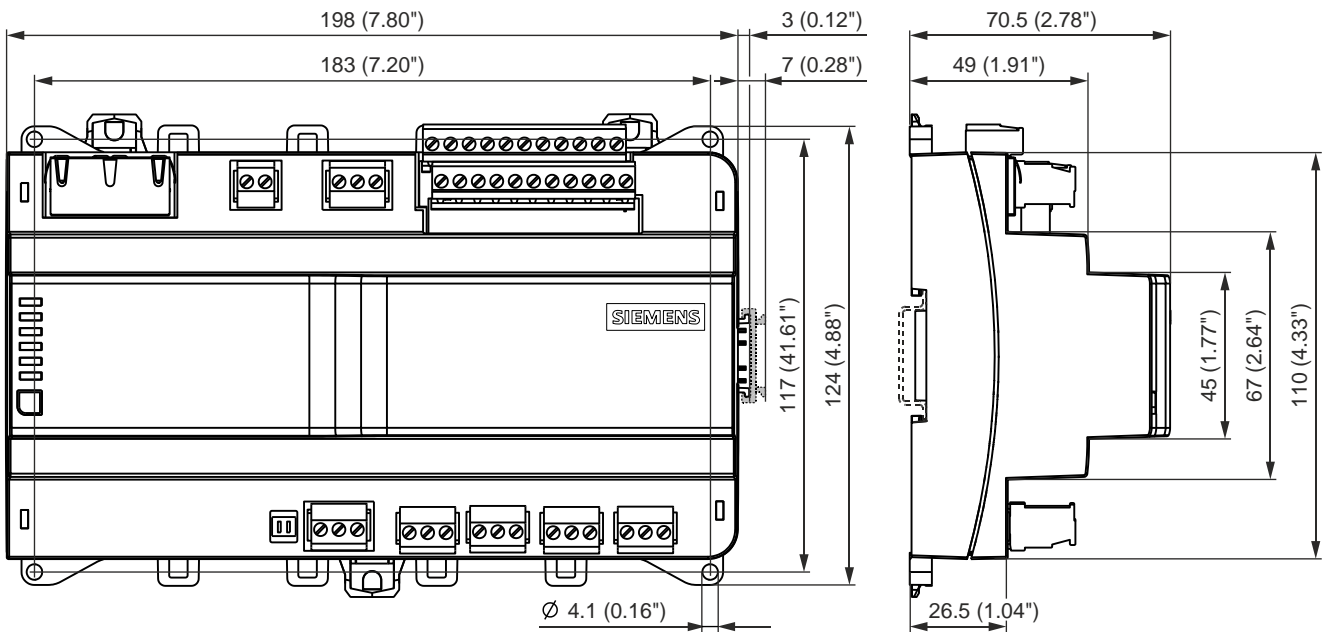

Automation station PXC4.E16 with 3 TXM modules

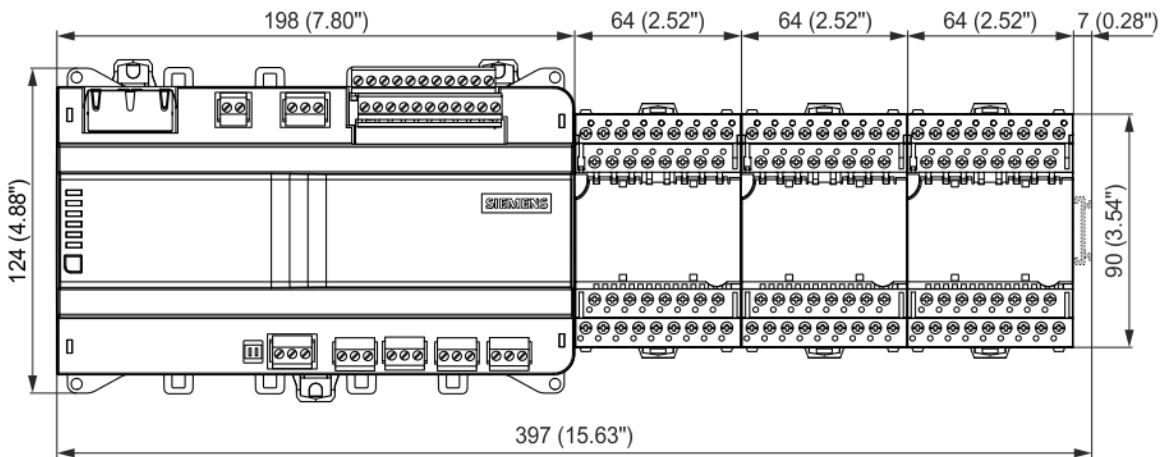

Issued by
Siemens Switzerland Ltd
Smart Infrastructure
Global Headquarters
Theilerstrasse 1a
CH-6300 Zug
+41 58 724 2424
www.siemens.com/buildingtechnologies

© Siemens Switzerland Ltd, 2020
Technical specifications and availability subject to change without notice.

A6V12062652_en--_a